



© extreme marquees 2009

3M x 3M Folding Marquee

Available Panel Colours

White:	C - 0,	M - 0,	Y - 0,	K - 0
Black:	C - 63,	M - 52,	Y - 51,	K - 100
Red:	C - 25,	M - 100,	Y - 78,	K - 6
Pink:	C - 10,	M - 90,	Y - 10,	K - 9
Green:	C - 74,	M - 35,	Y - 74,	K - 67
Dark Blue:	C - 90,	M - 80,	Y - 0,	K - 0
Light Blue:	C - 83,	M - 0,	Y - 12,	K - 23
Yellow:	C - 0,	M - 25,	Y - 100,	K - 0
Maroon:	C - 40,	M - 99,	Y - 89,	K - 60
Orange:	C - 0,	M - 64,	Y - 96,	K - 0

Please Note:

All artwork is printed in CMYK colour space
Please Convert all PMS or RGB artwork to an equivalent CMYK breakup

Please be aware that slight colour variation may occur in the printing process from a monitor output.
Place artwork in the designated layer of this document

This template is designed at a 10% scale of the final product.
Rasterised artwork supplied at 300dpi to suit this template size is the minimum requirement for a high quality final print

INSIDE HALF WALLS

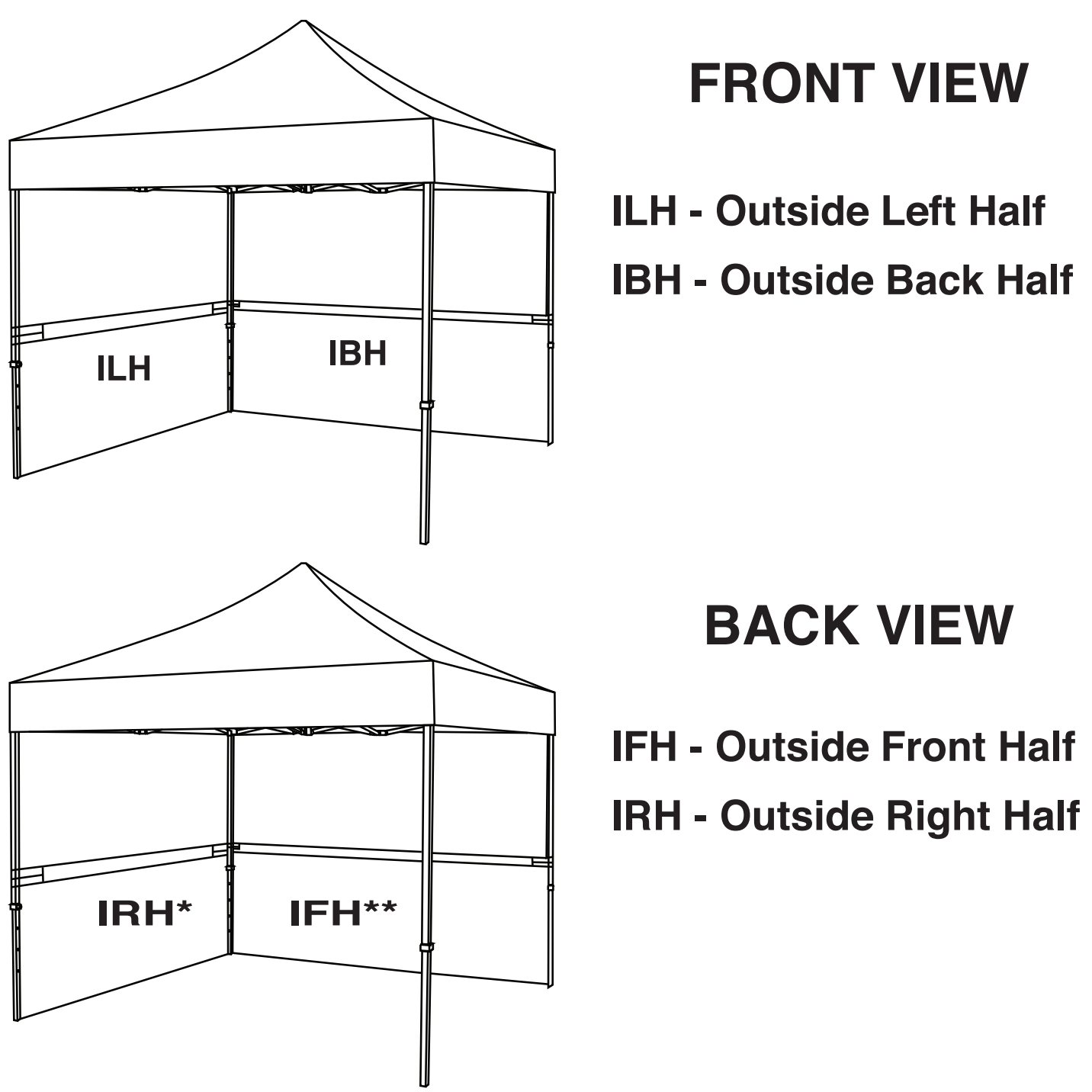

*Viewing this marquee from the front, this wall is on the right hand side
**Viewing this marquee from the front, this wall is at the front

LEFT HALF-WALL INSIDE PANEL

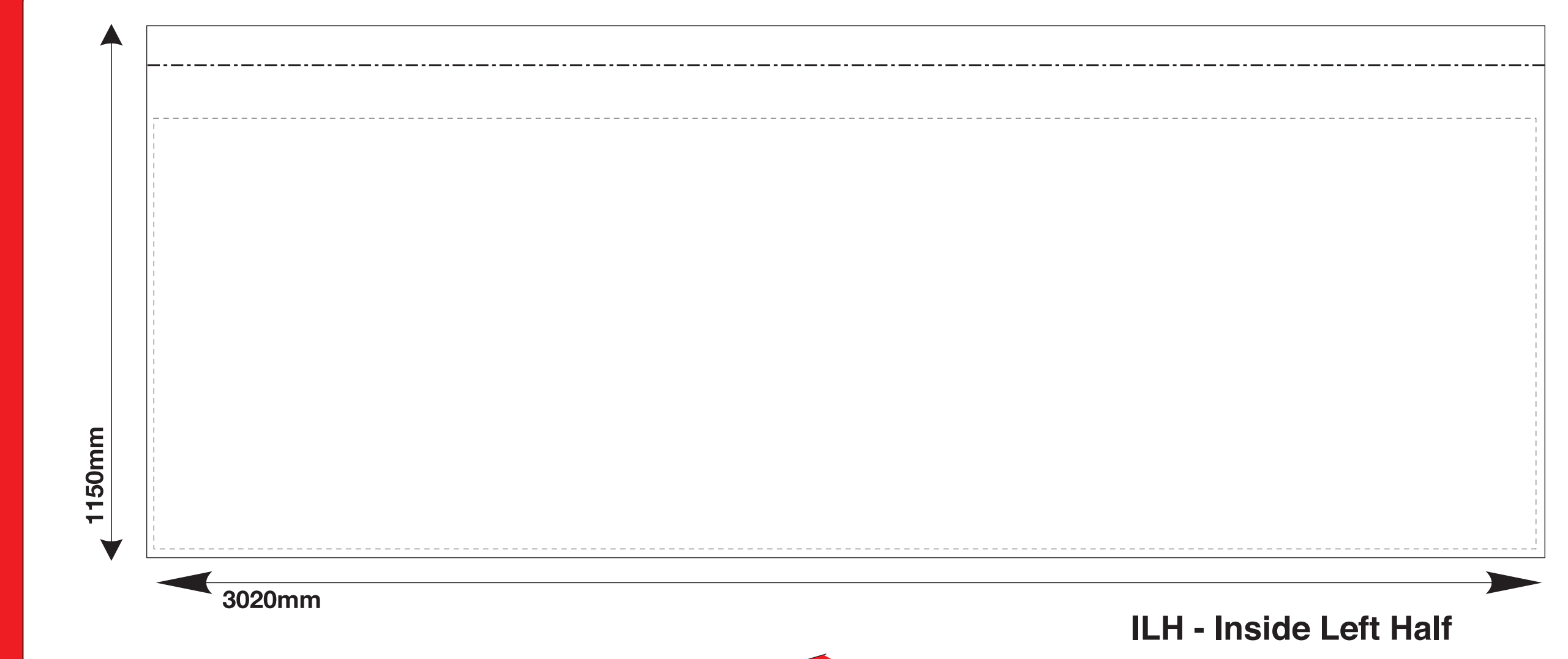

FRONT HALF-WALL INSIDE PANEL

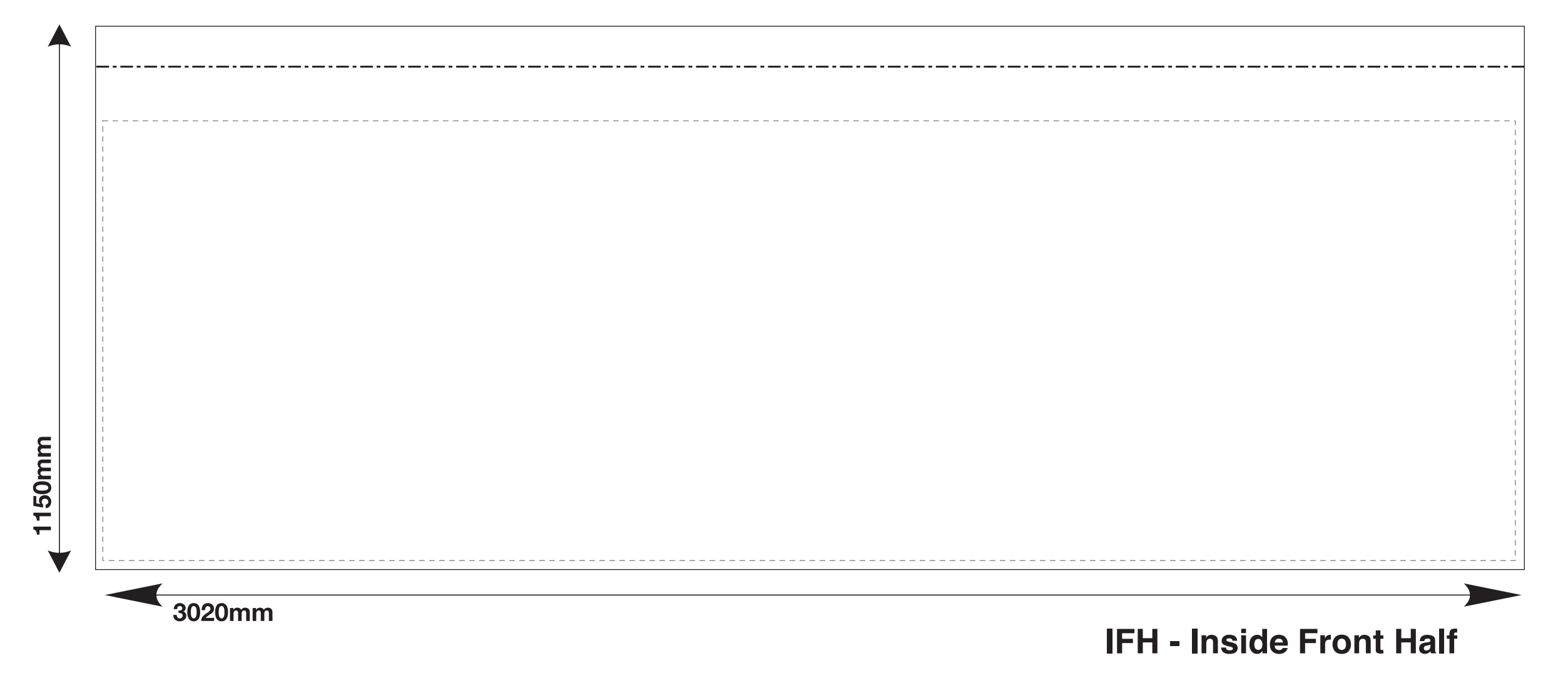

RIGHT HALF-WALL INSIDE PANEL

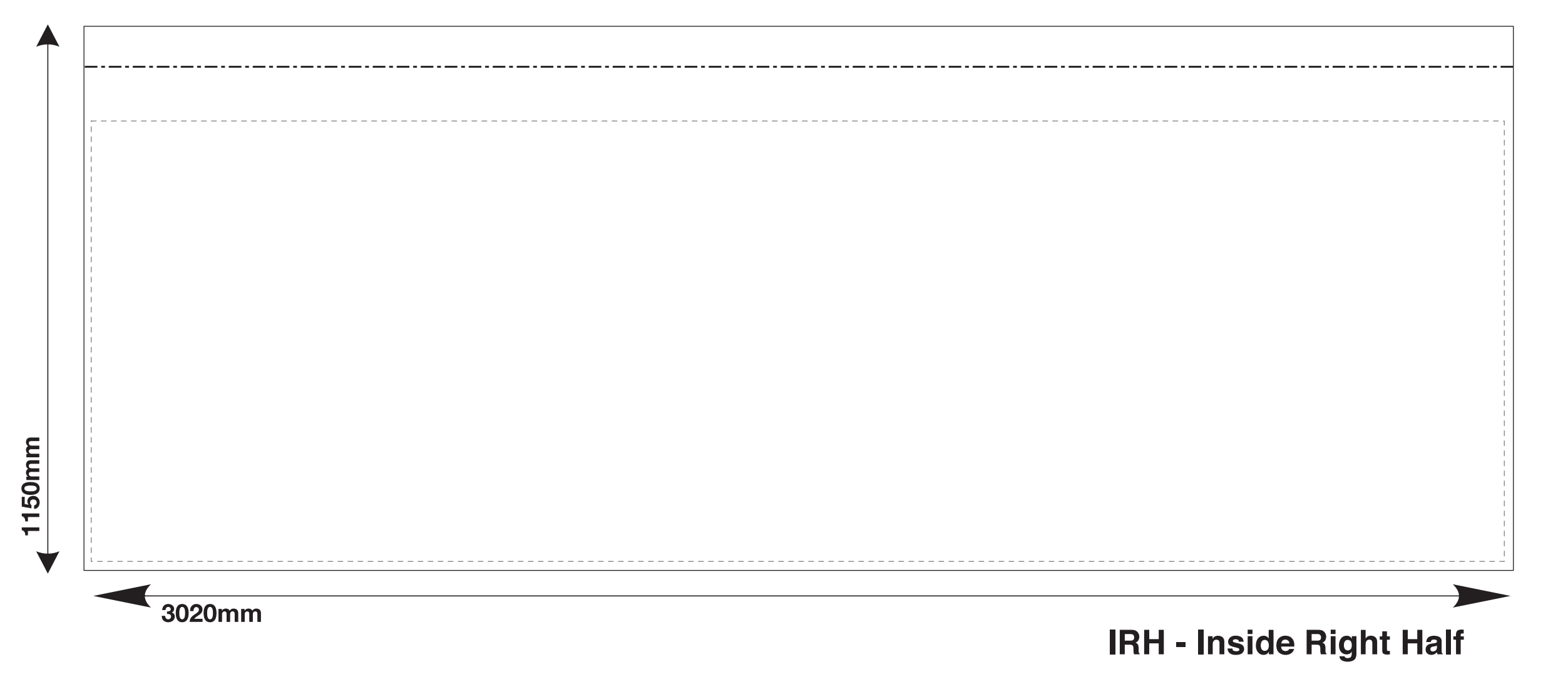

BACK HALF-WALL INSIDE PANEL

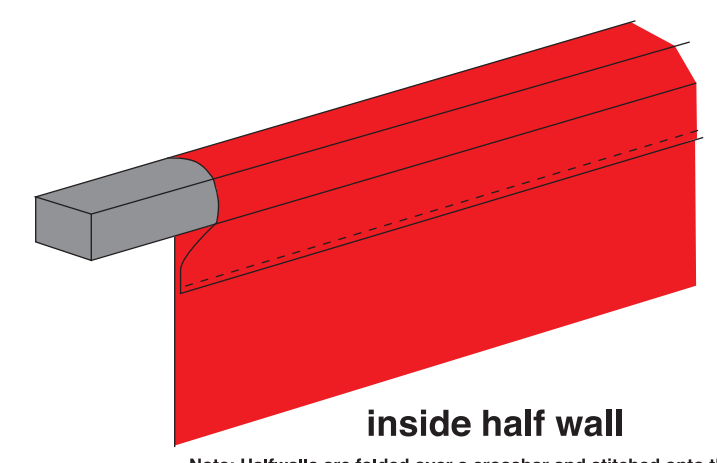
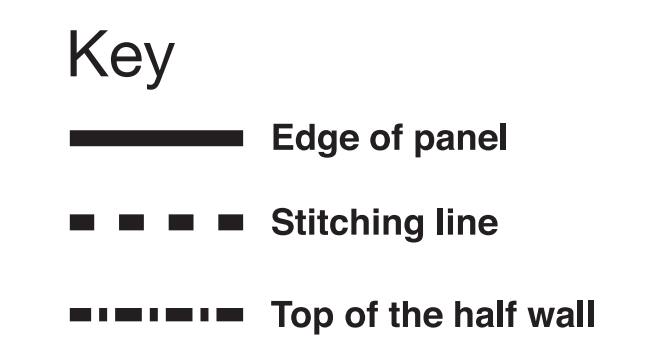
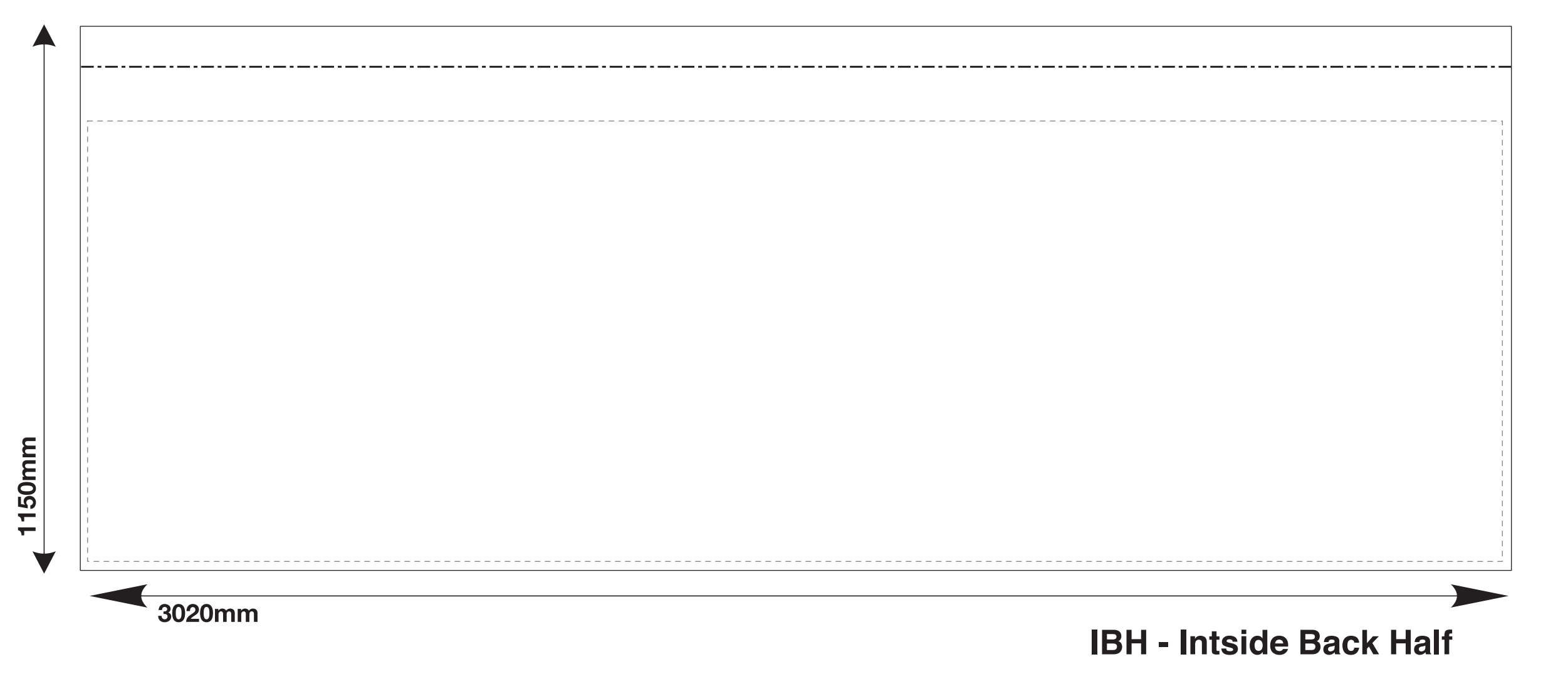

Note: Halfwalls are folded over a crossbar and attached onto the inside side.
For front side printing, the artwork should be up to the designated 'top of the halfwall' line. Inside wall artwork should finish at the stitching line.

OUTSIDE HALF WALLS

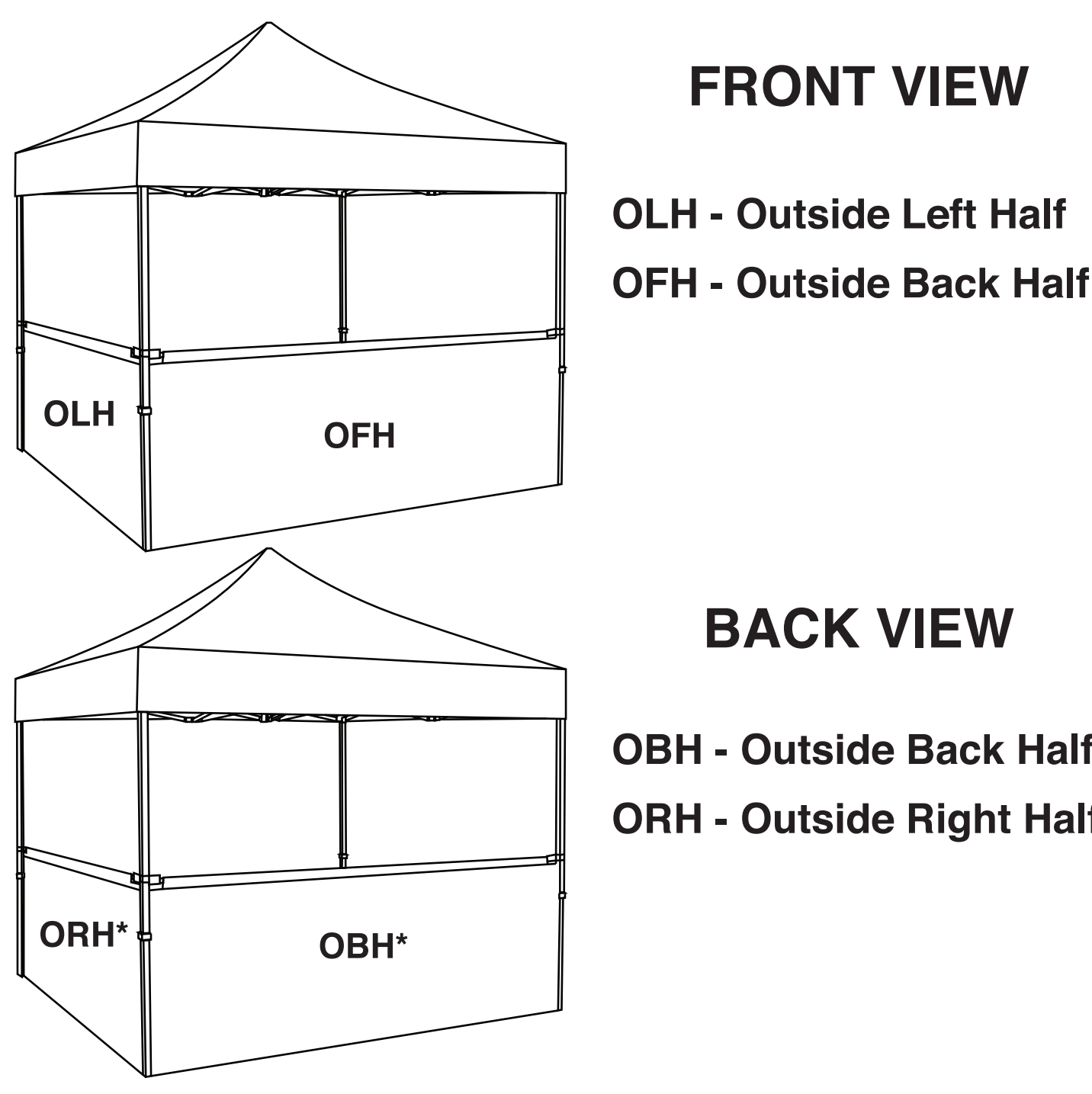

*Viewing this marquee from the front, this wall is on the right hand side

LEFT HALF-WALL OUTSIDE PANEL



FRONT HALF-WALL OUTSIDE PANEL

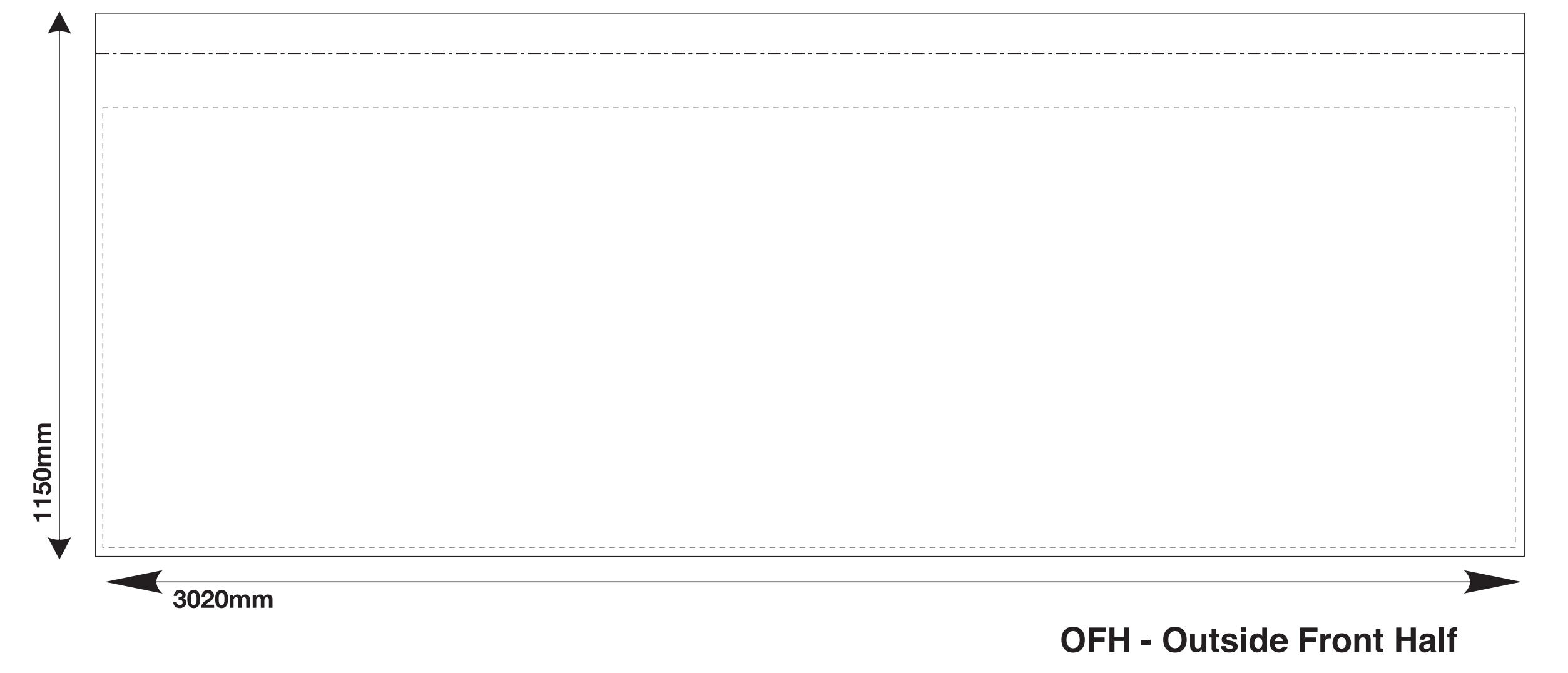

RIGHT HALF-WALL OUTSIDE PANEL

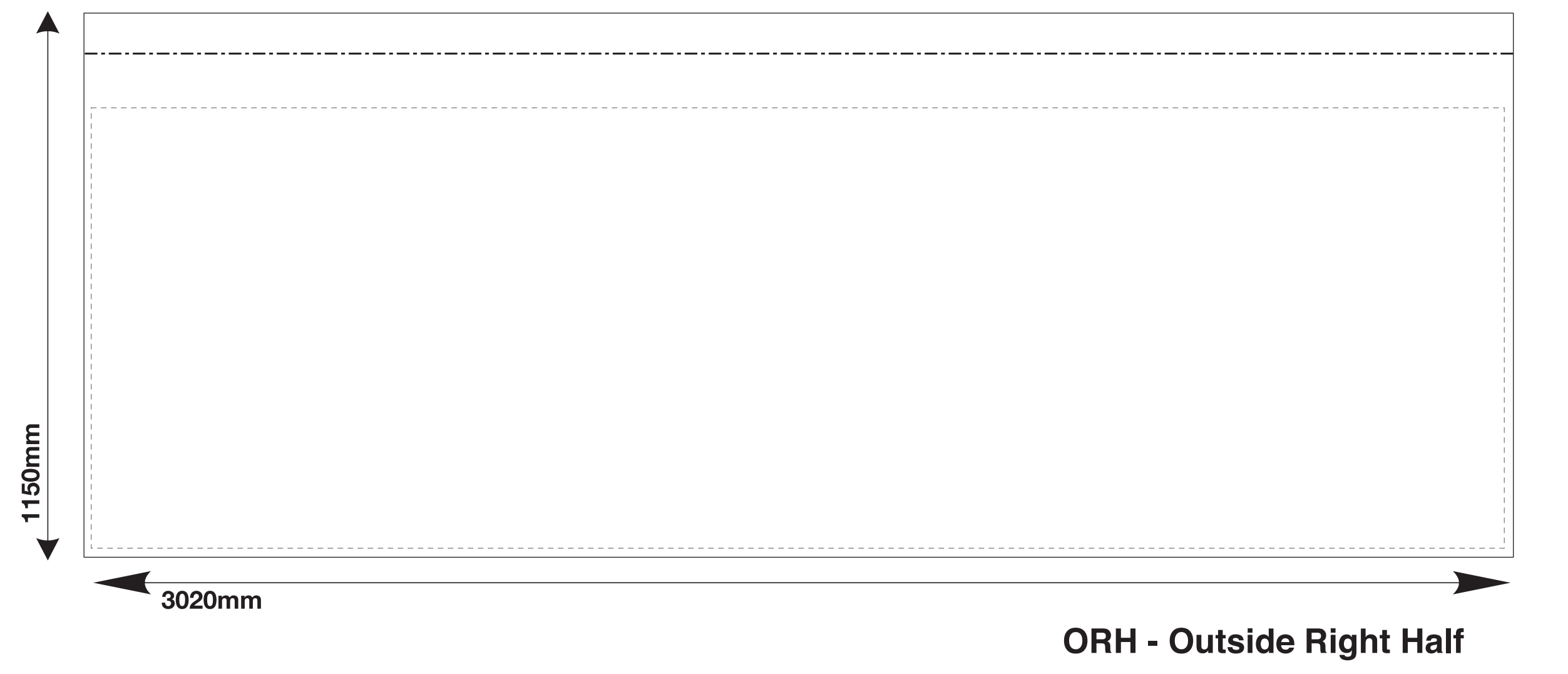

BACK HALF-WALL OUTSIDE PANEL

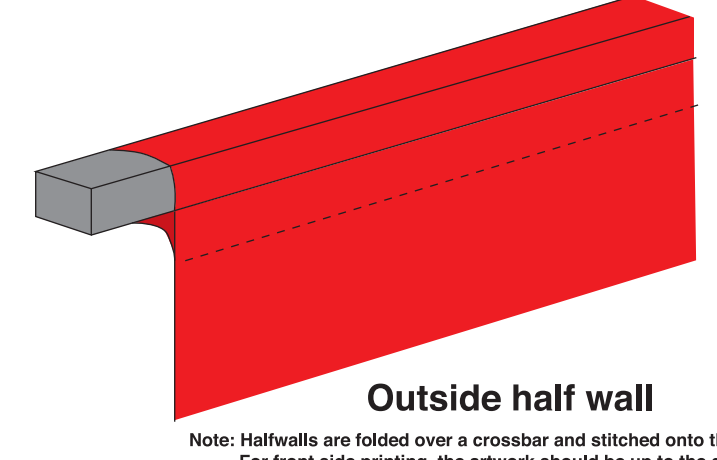
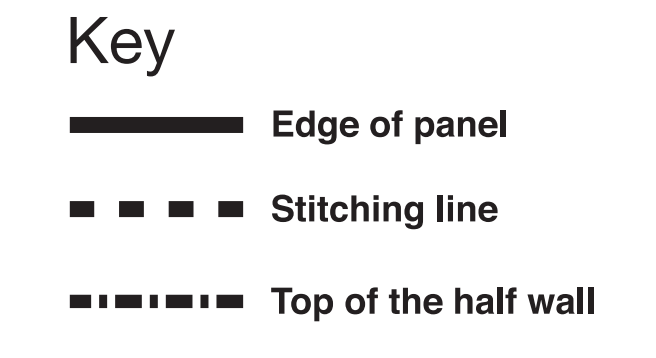
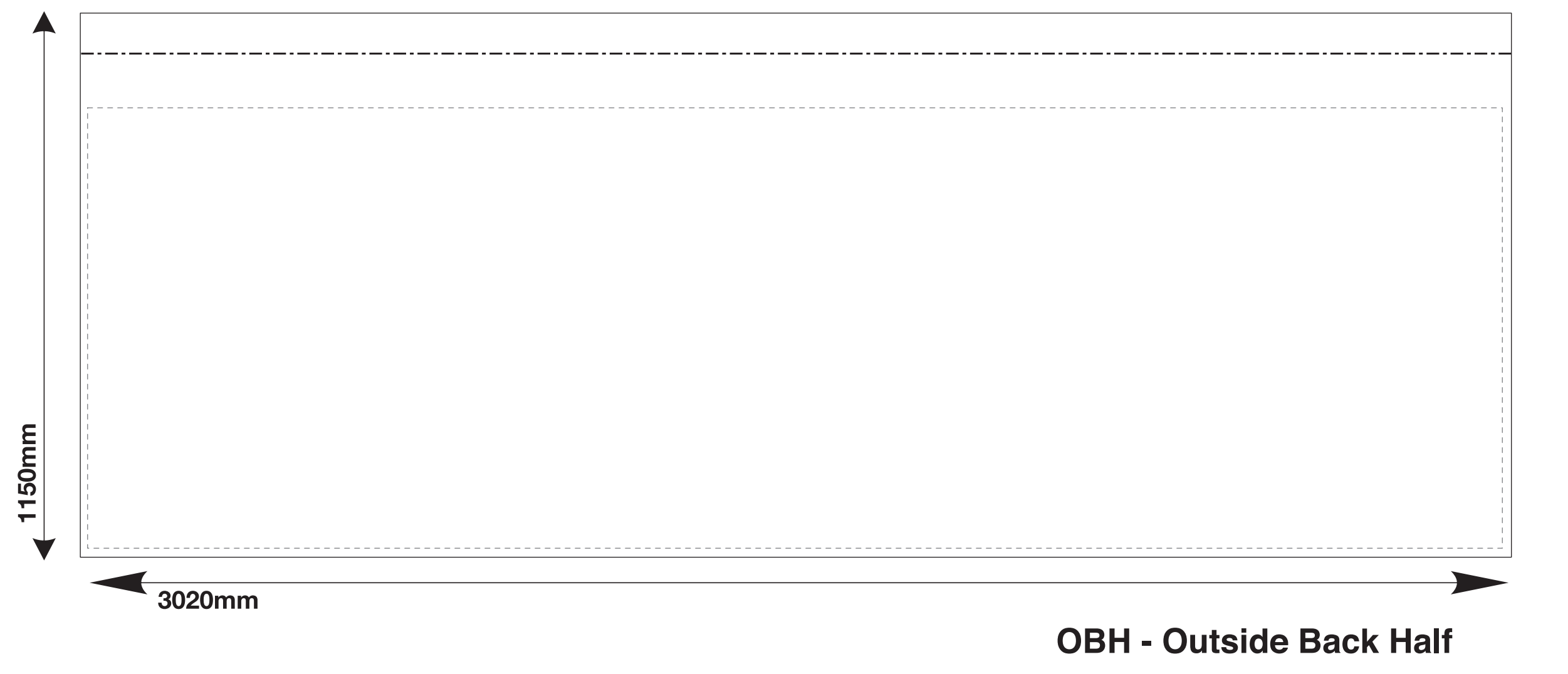

Note: Halfwalls are folded over a crossbar and attached onto the inside side.
For front side printing, the artwork should be up to the designated 'top of the halfwall' line. Inside wall artwork should finish at the stitching line.